

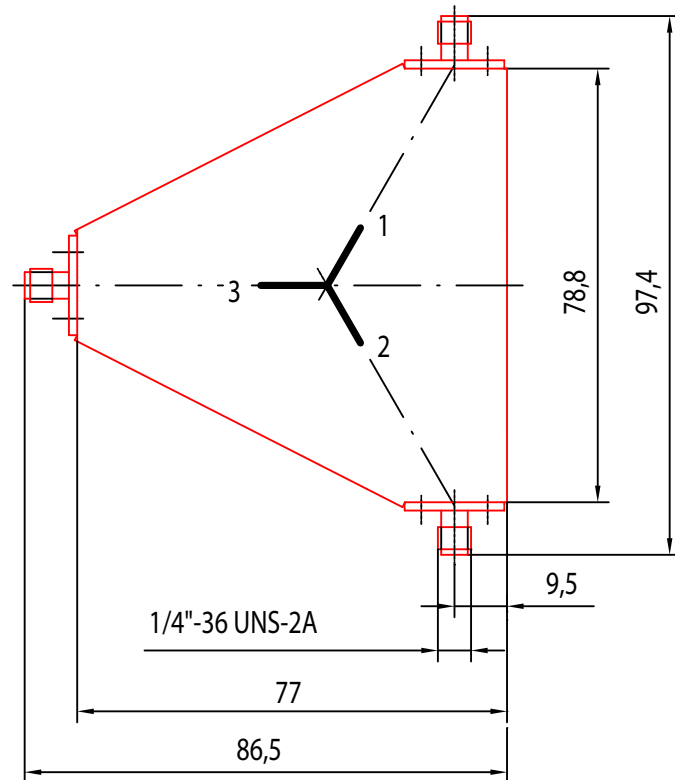

A

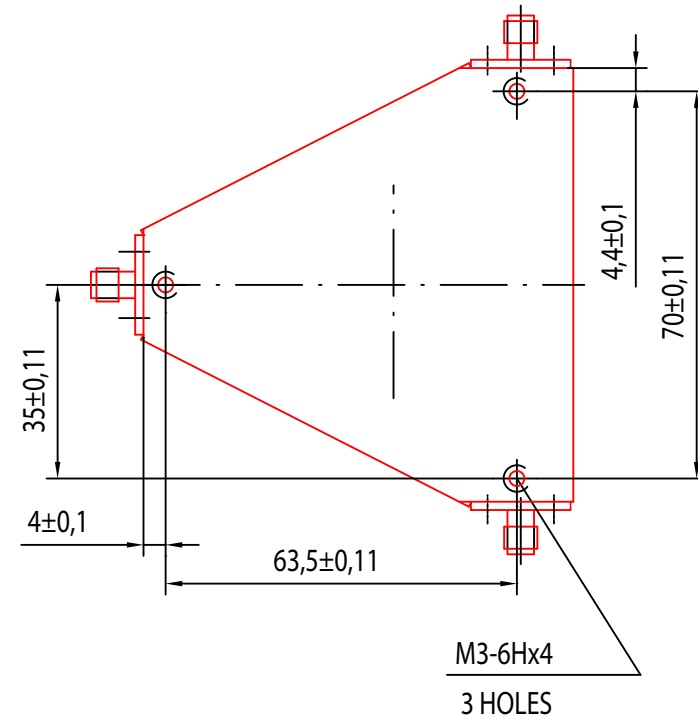

A



UNLESS OTHERWISE SPECIFIED DIMENSIONS ARE IN MM TOLERANCES ON	APPROVALS		DATE	 D&M Co "Ferrit-Quasar" 196084, Russia, St. Petersburg, Chernigovskaya St. 8 Phone/fax : 7 812 3887915/7 812 3883145 E-mail : info@ferrite-quasar.ru WWW : www.ferrite-quasar.ru
	DRAWN	SEROVA	10.01.12	
DECIMALS ANGLES .X± .1 .XX± - .XXX± -	CHECKED	GOROBETS	10.01.12	3CCB15-1-Sfff OUTLINE DRAWING
	ISSUED			
MATERIAL				N° DWG FQ-C-0012
SURFACE COATING NICEL PLATED	SIZE A3	SCALE 1:1		
	SHEET -	OF 1		